

Varenummer: 203160M1675B4V

Beskrivelse: E+G Justerfod
GN 31-60-M16-75-B4-V

Note: V Uden møtrik, udvendig sekskant i toppen, spændeflade i bunden

Mål

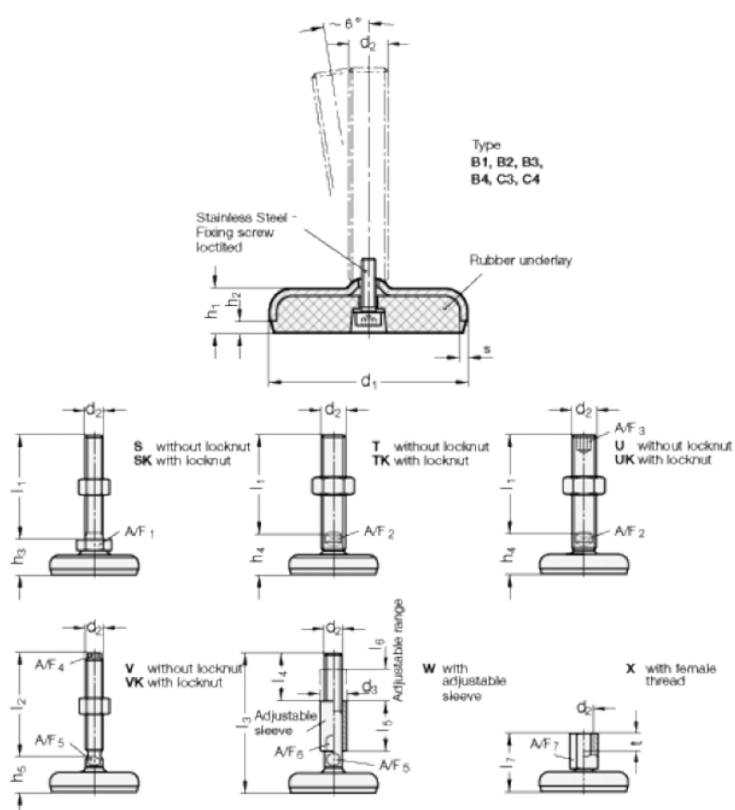

A/F4	= 10	s = 3
A/F5	= 12	
d1	= 60	
d2	= 16	
h1	= 16	
h2	= 4	
h5 +4.0/0	= 27	
l2	= 75	